

# WILEY® MILL BROCHURE

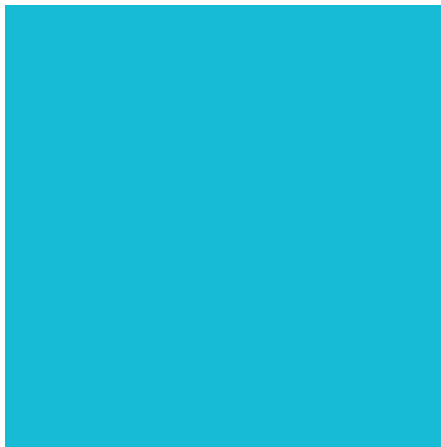

Experience reproducible sample preparation for reliable analysis results with the Wiley grinding mills.

# ABOUT WILEY® MILL

Consistent sample preparation is the cornerstone for reliable and accurate results which is why Thomas Scientific designed the Wiley® Mill & Mini-Mills. Thomas Scientific presents an array of cutting-edge mills and crushers designed for coarse, fine, and ultrafine size reduction across a wide range of materials. With a variety of grinding tools and accessories, our instruments ensure contamination-free and dependable sample preparation before laboratory analysis, securing the integrity of your research.

## Unique Advantage: Thomas Brands

Join a legacy of scientific excellence! For over 120 years, we've been powering scientific breakthroughs across the globe. In the journey of progress, three timeless priorities consistently guide the selection of life science solutions: quality, value & availability. That's why Thomas Scientific built an essential portfolio designed exclusively for scientists, researchers, and laboratories worldwide.

*Thomasci.com*

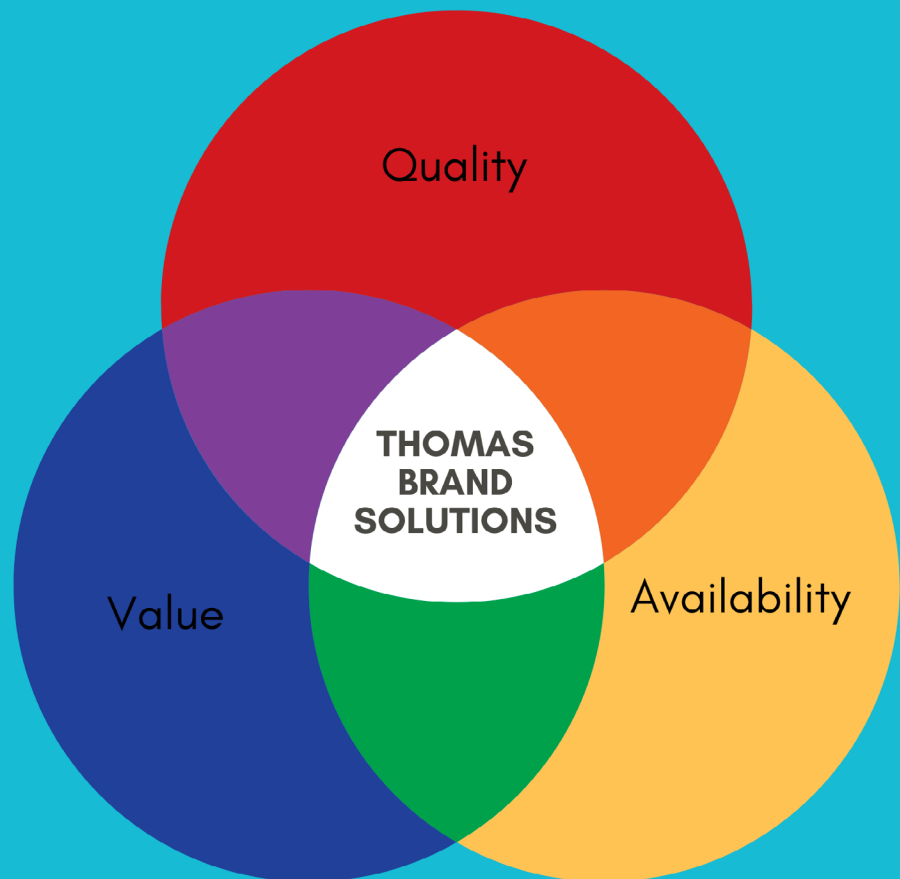

# TABLE OF CONTENTS



## MILLS

Wiley® Mill 4.....	5
Wiley® Mini Mill .....	6













## PARTS AND ACCESSORIES

Cutter Heads & Knives .....	8
Rotating and Stationary Blades .....	8
Sieves and Screens .....	8
Jars & Jar Holders .....	9
Plungers .....	9
Vacuum Recovery Systems .....	9
Hopper .....	9
Parts and Accessories .....	9
Mill Stand .....	9

## INFORMATION

Wiley® Mill Ordering Checklist .....	11
Technical Support .....	11

## INDUSTRIES

-  Agriculture
-  Analytics
-  Biology/Biotech
-  Cannabis
-  Chemistry/Plastics
-  Construction Materials
-  Energy
-  Engineering/ Electronics
-  Environmental
-  Food
-  Geology/ Metallurgy
-  Glass/ Ceramics

We offer in house technical support  
Technical Support: [technicalproductsupport@thomassci.com](mailto:technicalproductsupport@thomassci.com)

All Wiley® and Mini Mills come with a 3 year warranty from date of manufacturing.

Demo units for the Wiley Mill are now available. These units offer a unique opportunity to experience superior performance and reliability. Reach out to your Thomas rep to schedule a demonstration.



Aimed to provide precise chemical and physical analyses by achieving optimal homogenization of specimens to the required analytical quality.

---

# MILLS



# WILEY® MILL 4

The Wiley® Mill 4 single-speed large heavy duty Cutting Mill features a 7.75-inch diameter sealed cutting chamber with six stationary blades and a rotating cutting head with four replaceable cutting blades that revolve at high speed to produce a shearing action that minimizes heat build-up.



## THE NEXT GENERATION MODEL WILEY® MILL 4

### ADDITIONAL DETAILS

- Applications include: feed and grain testing, bio-fuels, recycling, advanced materials, performance materials
- Samples introduced through the hopper are swept around by the rotor until they are cut to sufficient fineness to pass through the sieve
- Ideal for milling of a wide range of materials, including wood chips, wood wastes, cover crops, dried distillers grains, cannabis/hemp, municipal solid waste, plastic waste and more.
- Available in 115V 60Hz or 230V 50Hz Configuration
- Select Benchtop or floor stand mounted model - Includes the following; 1x Plunger, 1x Stainless Steel Hopper, 3x Sieves (0.5mm, 1mm & 2mm), 1x Jar adaptor, 3x 16oz glass jars, 1x Toolset, 1x rotating cutter head with 4x rotating blades, 6x stationary cutting blades, and 1x brush.

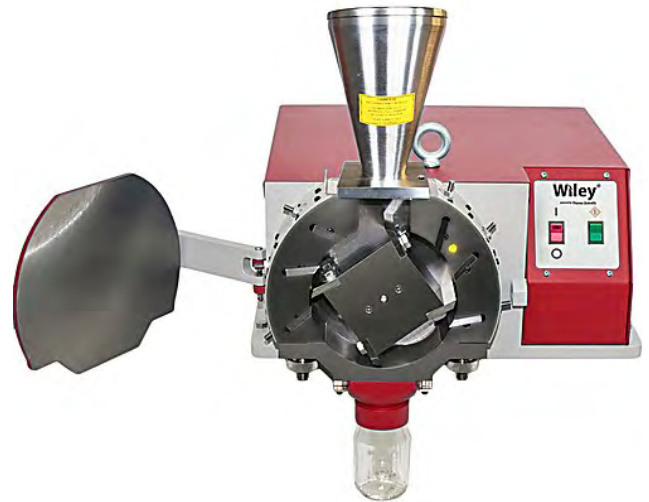

Thomas Part #	Description
23A00D303	Wiley® 4 Mill 115V 60Hz
23A00D304	Wiley® 4 Mill 115V 60Hz w/ Floor Stand
23A00D305	Wiley® 4 Mill 230V 50z
23A00D306	Wiley® 4 Mill 230V 50Hz w/ Floor Stand

# WILEY® MINI MILL

The Wiley® Mini benchtop cutting mill features a steel 1.575-inch diameter sealed cutting chamber with two adjustable stationary blades and a rotating cutting head with four cutting edges.



## THE NEXT GENERATION MODEL WILEY® MINI MILL

### ADDITIONAL DETAILS

- Applications include: feed and grain testing, bio-fuels, recycling, advanced materials, performance materials
- Ideal for milling of a wide range of materials, including wood chips, wood wastes, cover crops, dried distillers grains, cannabis/hemp, municipal solid waste, plastic waste and more.
- Variable Speed Model allows for variable speed operation of 0 - 2,400 RPMs with high torque.
- Available in 115V (60Hz) and 230V(50Hz) configurations
- Includes stainless steel hopper with cover, wooden plunger, one rotating cutting head, one set of stationary blades, three (3) stainless steel sieves (20, 40 & 60 mesh), one jar adapter, one 4oz collection jar, and cleaning brush.



Thomas Part #	Description
23A00D287	Wiley® Mini Mill, Single Speed, 115 60HZ
23A00D288	Wiley® Mini Mill, Single Speed, 230V 50HZ
23A00D289	Wiley® Mini Mill, Variable Speed, 115V 60HZ
23A00D290	Wiley® Mini Mill, Variable Speed, 230V 50HZ

Wiley mills provide efficient size reduction of heterogeneous material mixes and are also suitable for grinding soft, medium-hard, fibrous or elastic samples. The Wiley and Mini Mill are safe and easy to operate. Our selection of accessories can support a variety of applications in your process.

---

# PARTS AND ACCESSORIES

# PARTS AND ACCESSORIES



Mesh Sieve



Mini Mill Sieves

## CUTTER HEAD & KNIFES

Wiley® Mill 4 Part #	Description
23A00D314	4 Blade, Rotating Cutter Head, Steel
23A00D315	6 Blade, Rotating Cutter Head, Steel
3375P72	Knife Cam Lock For E10 TO E70
Wiley® Mini Mill Part #	Description
23A00D295	Standard Tool Steel Rotating Cutter Head
23A00X005	440C SS Rotating Cutter Head
23A00X006	VANAX Rotating Cutter Head

## ROTATING & STATIONARY BLADES

Wiley® Mill 4 Part #	Description
23A00A932	Stationary Blade Set SS (Set of 6)
23A00A933	Rotating Blade Set SS (Set of 4)
23A00D308	Blade Gapping Kit 0.008" Blade Gap
23A00D312	Rotating Blades, set of 4, Standard Tool Steel
23A00D313	Stationary Blades, set of 6, Standard Tool Steel
23A00H892	Rotating Blades, Set of 4, 440C Stainless Steel
23A00H893	Stationary Bades, Set of 6, 440C Stainless Steel
23A00H894	Rotating Blades, Set of 4, 316 Stainless Steel
23A00H895	Stationary Blades, Set of 6, 316 Stainless Steel
23A00H896	Rotating Blades, Set of 4, Vanax Superclean Steel
23A00H897	Stationary Blades, Set of 6, Vanax Superclean Steel
Wiley® Mini Mill Part #	Description
23A00D296	Standard Tool Steel Stationary Blades, PKG of 2
23A00X007	440C SS Stationary Blades PKG of 2
23A00X008	VANAX Stationary Blades PKG of 2

## SIEVES & SCREENS

Wiley® Mill 4 Part #	Description
23A00H554	Screen Shim Plate (for use with 60 Mesh Sieve)
23A00D320	0.5 MM S/S 316 Sieve
23A00D321	1 MM S/S 316 Sieve
23A00D330	10 MM S/S 316 Sieve
23A00D331	11 MM S/S 316 Sieve
23A00D332	12 MM S/S 316 Sieve
23A00D322	2 MM S/S 316 Sieve
23A00D323	3 MM S/S 316 Sieve
23A00D324	4 MM S/S 316 Sieve
23A00D325	5 MM S/S 316 Sieve
23A00D326	6 MM S/S 316 Sieve
23A00H553	60 Mesh Etched Sieve
23A00D327	7 MM S/S 316 Sieve
23A00D328	8 MM S/S 316 Sieve
23A00D329	9 MM S/S 316 Sieve
Wiley® Mini Mill Part #	Description
23A00D297	20 Mesh Etched Sieve
23A00D298	40 Mesh Etched Sieve
23A00D299	60 Mesh Etched Sieve
23A00D301	1MM Sieve
23A00D300	10 Mesh Sieve
23A00D302	2MM Sieve
23A00G168	100 Mesh Etched Sieve
23A00G167	80 Mesh Etched Sieve



# PARTS AND ACCESSORIES

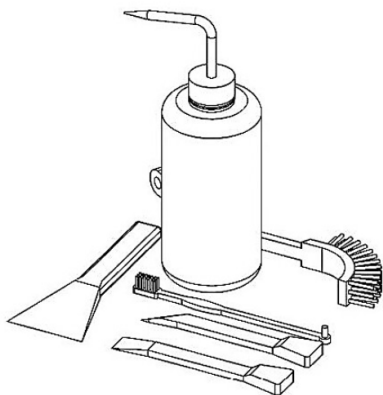

## PARTS AND ACESORIES

Wiley® Mill 4 Part #	Description
23A00Q900	Bearing Pillow Block, Legacy Model 4
23A00D311	Model 4 Mill Cleaning Kit - Brushes, scrapers and wash bottle
3375P52	Door Latch Bolt For E10 to E70
Wiley® Mini Mill Part #	Description
23A00D291	Mini Mill Cleaning Kit

## PLUNGERS

Wiley® Mill 4 Part #	Description
23A00D293	PTFE Plunger
23A00D294	Wooden Plunger
Wiley® Mini Mill Part #	Description
23A00D309	Replacement PTFE Plunger Designed For Use With E3700.A.H.P.S
23A00D310	Replacement Wood Plunger Designed For Use With E3700.A.H.P.S

## VACUUM RECOVERY SYSTEMS

Wiley® Mill 4 Part #	Description
23A00X011	16oz Jar Vacuum Recovery System, Standard, 115V 60Hz
23A00X009	30 Gallon Mill Vacuum Recovery System, 115V 60Hz
23A00X010	55 Gallon Mill Vacuum Recovery System, 115V 60Hz
Wiley® Mini Mill Part #	Description
23A00X003	New Mini Mill Vacuum recovery system, 115V 60Hz



## HOPPERS

Wiley® Mill 4 Part #	Description
23A00D307	316 Stainless Steel High Flow Hopper with PTFE plunger
23A00X012	300 Series Stainless Round Top Hopper
23A00X013	316 Stainless Hopper loading tray

## JARS & JAR HOLDERS

Thomas Part #	Description
23A00D292	4OZ Straight Collection Jar With Lid
23A00X004	4OZ Straight Collection Jar With Lid, PKG OF12
23A00D318	16OZ Mason Jar PKG 12 W/ Lid
23A00D319	32OZ Mason Jar PKG 12 W/ Lid
23A00D317	Wide Mouth Jar Holder

## MILL STAND

Wiley® Mill 4 Part #	Description
23A00D316	Powder Coated Steel Stand

Our Wiley Mills are designed for excellent performance, operating ease, safety and longevity in your lab.

We offer complimentary test grinding through a partnership with an application laboratory.

Technical support is available in house at Thomas Scientific.

---

# INFORMATION

## INFORMATION

### Free Test Grinding

Thomas Scientific offers exceptional customer support by providing individualized recommendations to find the optimum solution for your sample preparation.

We have partnered with an application laboratory to process and measure samples free-of-charge and give a recommendation on the method and instrument to meet your goals.

Scan or click here  
more information



### Size Reduction Principles

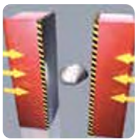

**Compression:**  
Pressure is applied to the material by crushing or pressing it between two surfaces causing it to fracture.

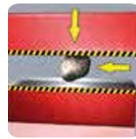

**Attrition:**  
The material is worn down by friction between particles or a material and a surface.

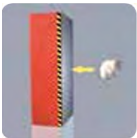

**Impact:**  
Hitting the material with a force, causing it to break apart.



**Cutting/Shearing:**  
Force applied parallel to the material of the surface causes the material to tear.

### Wiley® Mill Ordering Checklist:

- Grinding Mill
- Stand
- Blades
- Cutter Heads
- Sieve (smaller)
- Sieve (larger)
- Stainless Hopper
- Stainless Tray
- Plunger
- Blade Gapping
- Cleaning Kit
- Vacuum Separator
- Vacuum Hose Adaptor
- Jars



# CONNECT WITH US.

 [service@thomassci.com](mailto:service@thomassci.com)

 833.544.7447

 [thomassci.com](http://thomassci.com)

