

Fabrication materials: Stainless Steel 304L with electro-polished finish & Aluminium anodized connectors

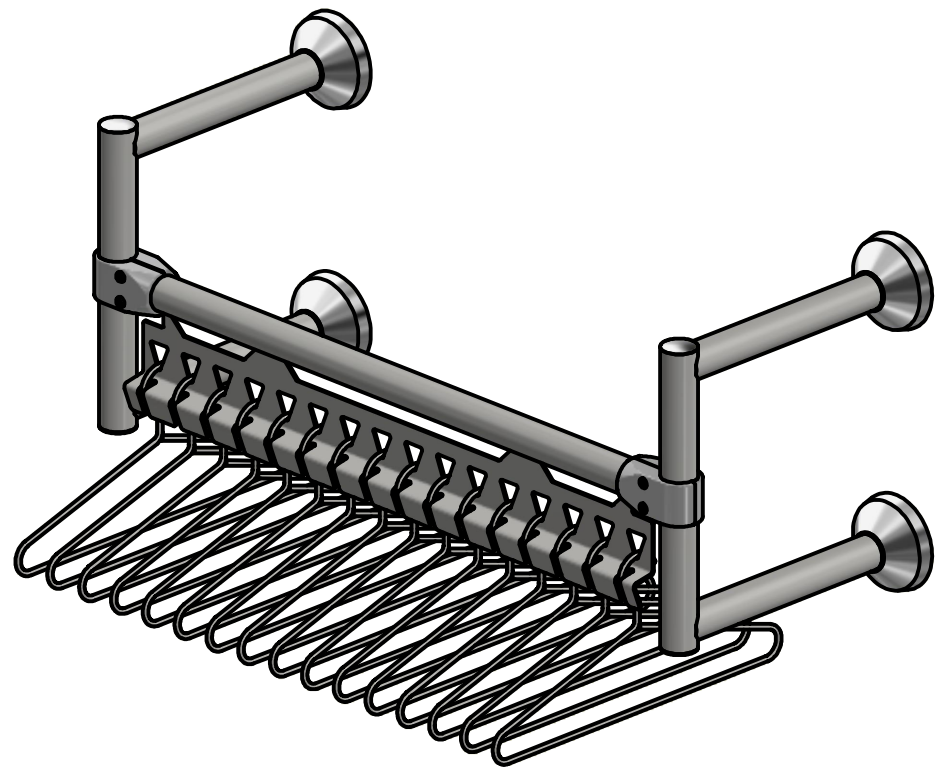
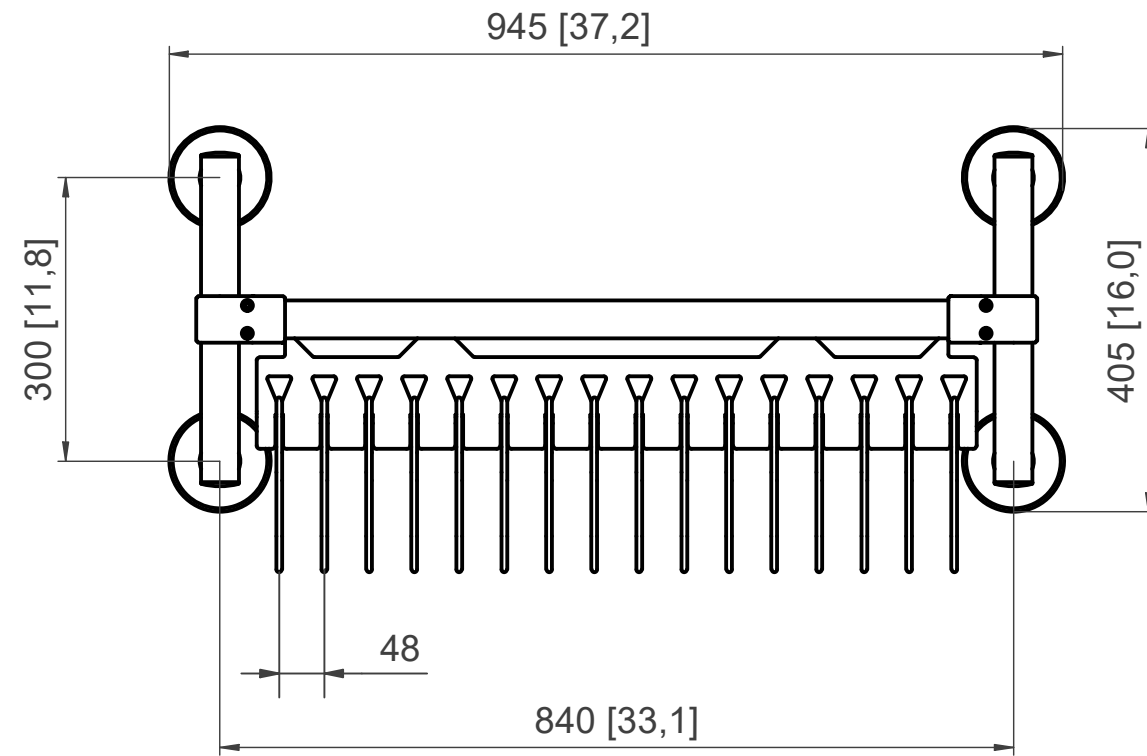
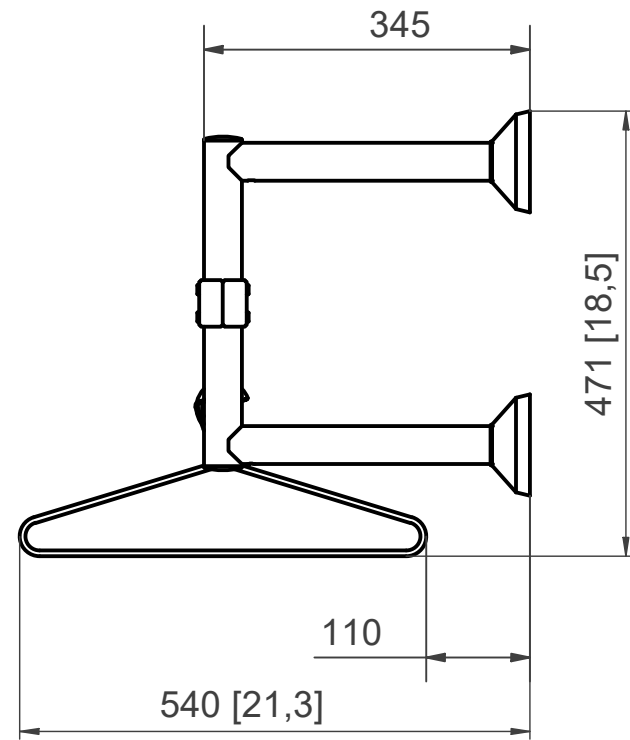

Estimation total weight 12 kg	VARIATION IN DIMENSIONS WITHOUT TOLERANCE IND. DIN 7168		PalbamClass EN HAROD IHUD	EUROPE PROJ 	
	BREAK EDGES 0.3x45	STATUS MEDIUM			REV
ALL RIGHTS STRICTLY RESERVED USE, REPRODUCTION OR ISSUE TO THIRD PARTY IN ANY FORM WHATEVER IS NOT PERMITTED UNLESS AUTHORIZED IN WRITING BY THE PROPRIETOR PalbamClass IL-18960 EN-HAROD IHUD-ISRAEL.	INNER RADIUS	SURF. ROUGH. PER ISO 1302	Wall Mount Gownrack 16		
	DATE	NAME	GRW16CMP		
	DESG	19/11/2007	Alexey	DWG. No.	PCGG0811-000
	APPR			SCALE	1:8
CONTROLLED COPIES OF THIS DOCUMENT HAVE A RED ISSUE DATE STAMP, THESE COPIES WILL BE UPDATED BY PALBAM CLASS INFORMATION SYSTEM. ANY OTHER COPY IS NOT CONTROLLED AND THEREFORE NOT UPDATED. PLEASE CHECK WITH INFORMATION SYSTEM FOR VALIDITY OF DOCUMENT.			SIZE	A3	
			SHEET	1 / 1	